

FasDiagTM OM123

Mans.io

User Manual

OBDII Car Diagnostic Scanner

Introduction

Thank you very much for choosing FasDiag OM123 OBDII Car Diagnostic Scanner. Please read this manual before using the product as it may contains some information you don't know. If you have any questions, please feel free to contact us via info@jdiag.com or send us message through amazon.

Package includes

OM123 OBDII Car Diagnostic Scanner
User Manual

Safety Precautions and Warnings

To prevent personal injury or damage to vehicles and/or the scan tool, read this instruction manual first and observe the following safety precautions at a minimum whenever working on a vehicle:

Mans.io

1. Always perform automotive testing in a safe environment
2. Do not attempt to operate or observe the tool while driving a vehicle. Operating or observing the tool will cause driver distraction and could cause a fatal accident.
3. Wear safety eye protection that meets ANSI standards.
4. Operate the vehicle in a well ventilated work area: Exhaust gases are Poisonous.
5. Put the transmission in PARK (for automatic transmission) or NEUTRAL (for manual transmission) and make sure the parking brake is engaged.
6. Keep the scan tool dry, clean, free from oil/water or grease. Use a mild detergent

on a clean cloth to clean the outside of the scan tool, when Necessary.

General Information

1. On-Board Diagnostics (OBD) II

The OBD II system is designed to monitor emission control systems and key engine components by performing either continuous or periodic tests of specific components and vehicle conditions. When a problem is detected, the OBD II system turns on a warning lamp (MIL) on the vehicle instrument panel to alert the driver typically by the phrase "Check Engine" or "Service Engine Soon". The system will also store important information about the detected malfunction so that a technician can accurately find and fix the problem. Here below follow three pieces of such valuable Information:

1. Whether the Malfunction Indicator Light (MIL) is commanded "on" or "Off";
2. Which, if any, Diagnostic Trouble Codes (DTCs) are stored;
3. Readiness Monitor status.

2. Diagnostic Trouble Codes (DTCs)

OBD II Diagnostic Trouble Codes are codes that are stored by the on-board computer diagnostic system in response to a problem found in the vehicle. These codes identify a particular problem area and are intended to provide you with a guide as to where a fault might be occurring within a vehicle. OBD II Diagnostic Trouble Codes consist of a five-digit alphanumeric code. The first character, a letter, identifies which control system sets the code. The other four characters, all numbers, provide additional information on where the DTC originated and the operating conditions that caused it to be set.

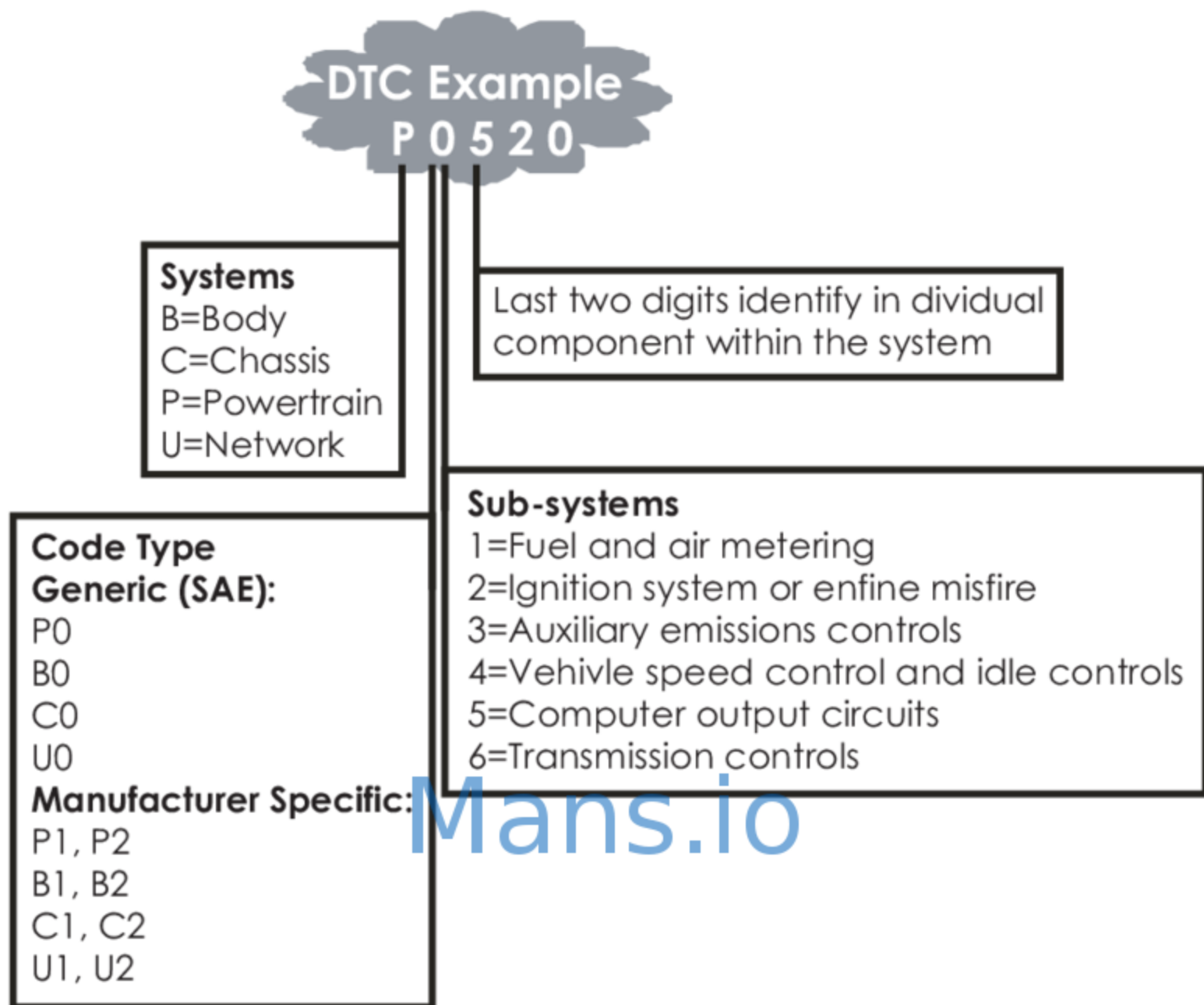

Figure 1-2: Explanation of a diagnostic trouble code.

Below is an example to illustrate the structure of the digits:

3. Location of the Data Link Connector (DLC)

The DLC (Data Link Connector or Diagnostic Link Connector) is the standardized 16-cavity connector where diagnostic scan tools interface with the vehicle's on-board computer. The DLC is usually located 12 inches from the center of the instrument panel (dash), under or around the driver's side for most vehicles. If the Data Link Connector is not located under the dashboard, a label should be there revealing its location. For some Asian and European vehicles, the DLC is located behind the ashtray and the ashtray must be removed to access the connector. If the DLC cannot be found, refer to the vehicle's

Figure 1-3: The DLC connector (left) can be found in the area of the car interior seen at right (black arrow).

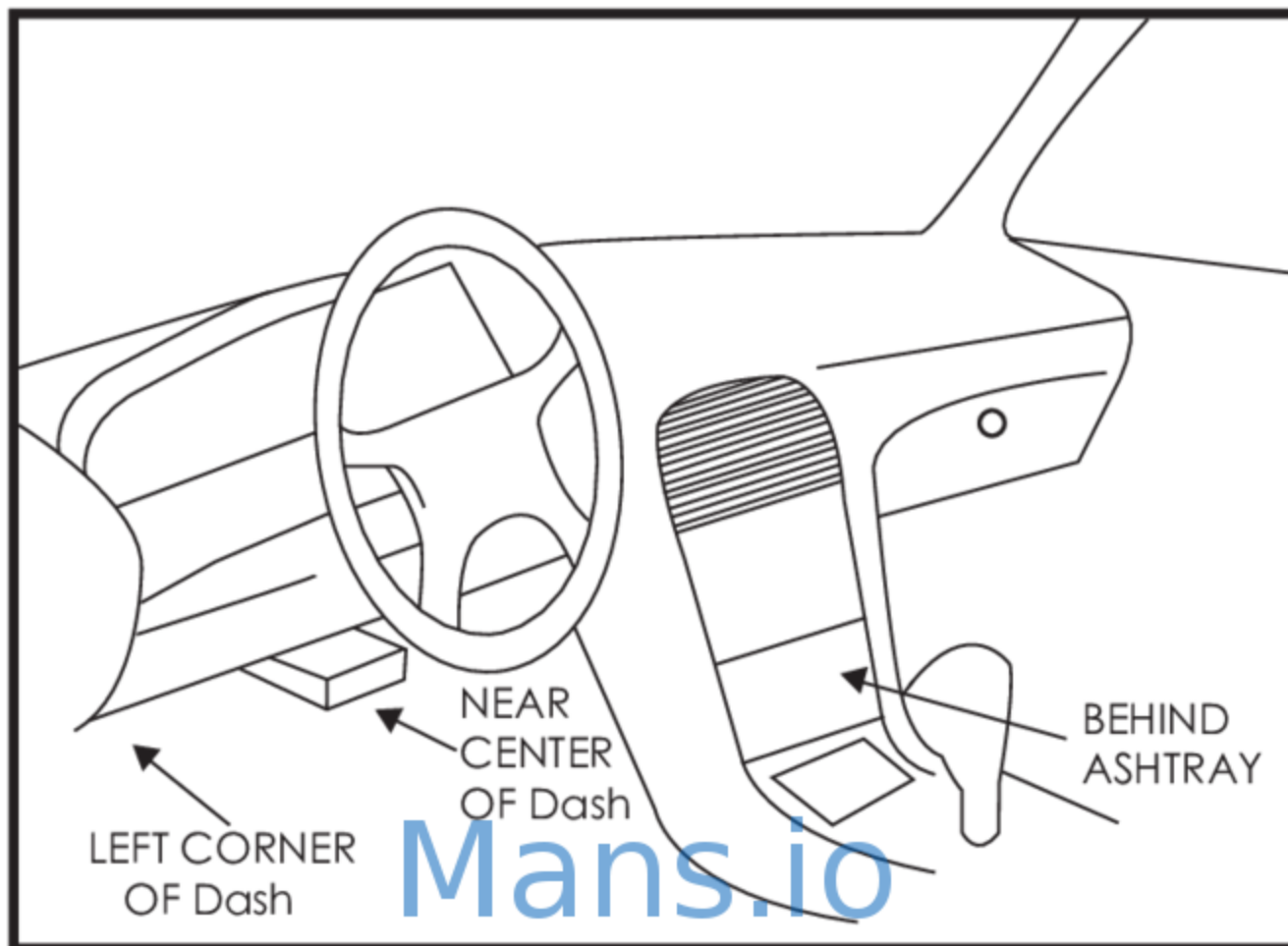

4. OBD II Definitions

Powertrain Control Module (PCM) -the OBD II terminology for the on-board computer that controls the engine and the drive train. Malfunction Indicator Light (MIL) -Malfunction Indicator Light (Service Engine Soon, Check Engine) is a term used for the light on the instrument panel. It is to alert the driver and/or the repair technician that there is a problem with one or more of vehicle's systems and may cause emissions to exceed federal standards. If the MIL illuminates with a steady light, it indicates that a problem has been detected and the vehicle should be serviced as soon as possible. Under certain conditions, the dashboard light will blink or flash. This indicates a severe problem and flashing is intended to discourage vehicle operation. The vehicle onboard diagnostic system can not turn the MIL off until necessary repairs are completed or the condition no longer exists.

DTC -Diagnostic Trouble Codes (DTC) these identify which section of the emission control system has malfunctioned.

Freeze Frame Data -When an emissions related fault occurs, the OBD II system not only sets a code, but also records a snapshot of the vehicle operating parameters to help in identifying the problem. This set of values operating parameters to help in identifying the problem. This set of values is referred to as Freeze Frame Date and may include important engine is referred to as Freeze Frame Date and may include important engine parameters such as engine RPM, vehicle speed, air flow, engine load, fuel pressure, fuel trim value, engine coolant temperature, ignition timing advance, or closed loop status.

Using the Scan Tool

1. Tool Description - OM123



1. LCD DISPLAY – Indicates test results. Backlit, 128 x 64 pixel display with contrast adjustment.
2. ENTER BUTTON – Confirms a selection (or action) from a menu.
3. EXIT BUTTON – Cancels a selection (or action) from a menu or returns to the menu. It is also used to exit DTC Lookup screen.
4. UP SCROLL BUTTON – Moves up through menu and submenu items in menu mode. When more than one screen of data is retrieved, moves up through the current screen to the previous screens for additional data.
5. DOWN SCROLL BUTTON – Moves down through menu and submenu items in menu mode. When more than one screen of data is retrieved, moves down through the current screen to next screens for additional data.
6. OBD II CONNECTOR – Connects the scan tool to the vehicle's Data Link Connector (DLC).

2. Specifications

1. Display: Backlit, 128 × 64 pixel display with contrast adjustment
2. Operating Temperature: 0 to 60°C (32 to 140 F°)
3. Storage Temperature: -20 to 70°C (-4 to 158 F°)
4. External Power: 8.0 to 18.0 V power provided via vehicle battery
5. Dimensions:
 - Length: 125 mm (5.00")
 - Width: 70 mm (2.80")
 - Height: 22 mm (0.90")
6. NW: 0.23kg (0.51lb), GW: 0.32kg (0.74lb)

3. Language

1. From the Main Menu, use the UP/DOWN scroll button to select the Language and press the ENTER button.

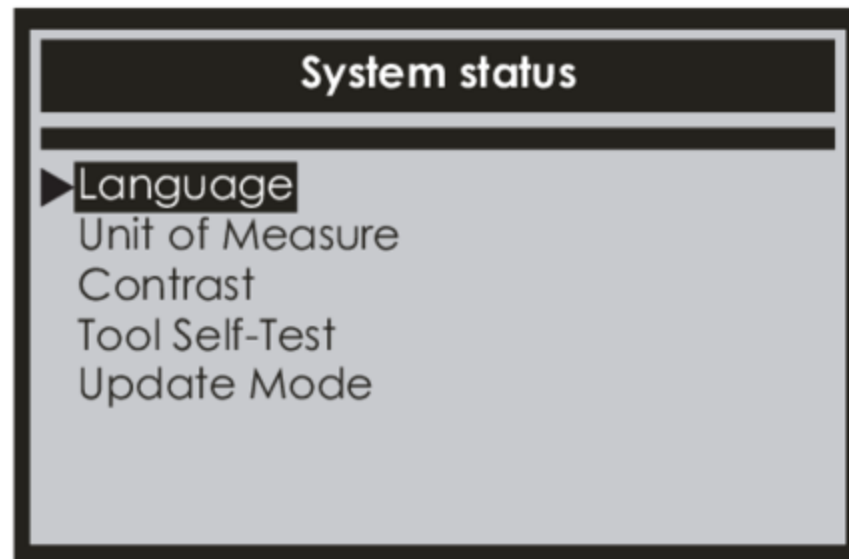

4. Contrast

1. From the Main Menu, use the UP/DOWN scroll button to select Contrast, and press ENTER.

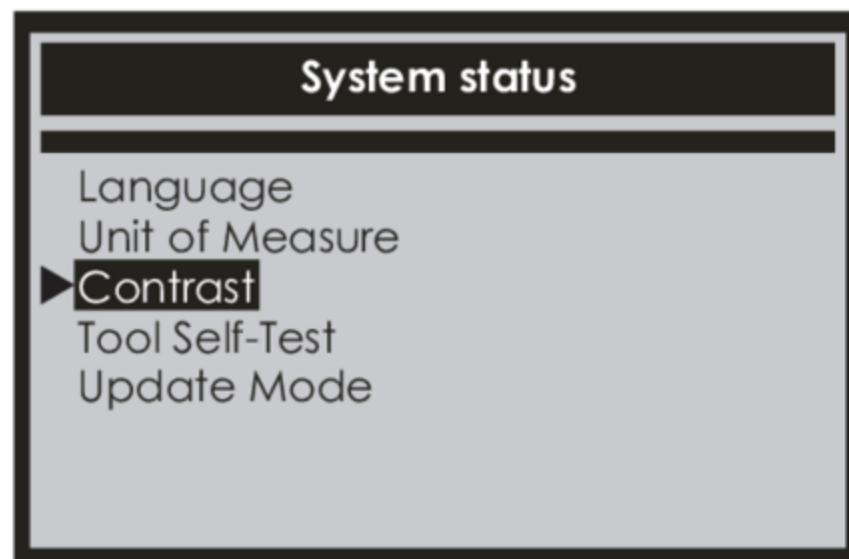

2. From the Contrast menu, use the UP/DOWN scroll button to increase or decrease contrast.

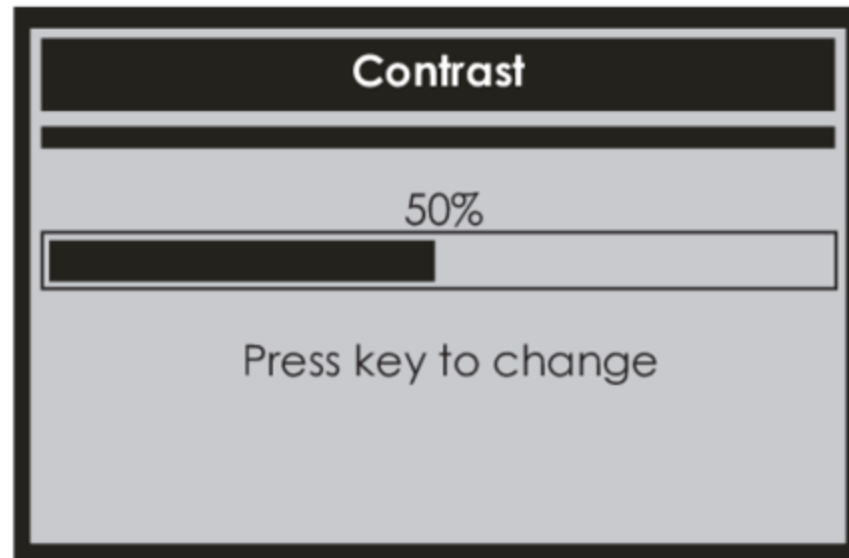

3. Press ENTER to save your settings and return to the previous menu.

5. Unit of Measure

Mans.io

1. From the Main Menu, use the UP/DOWN scroll button to select Measure, and press ENTER.

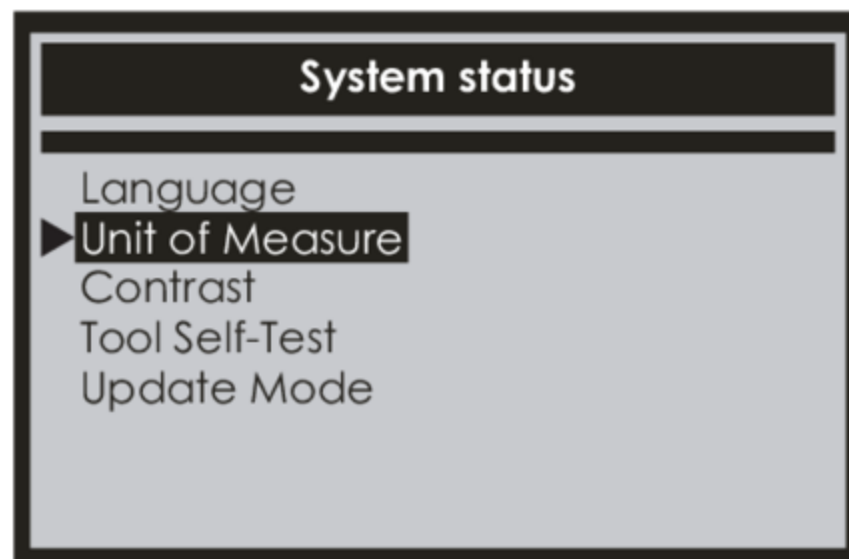

2. From the Unit of Measure menu, use the UP/DOWN scroll button to select the desired Unit of Measure.'

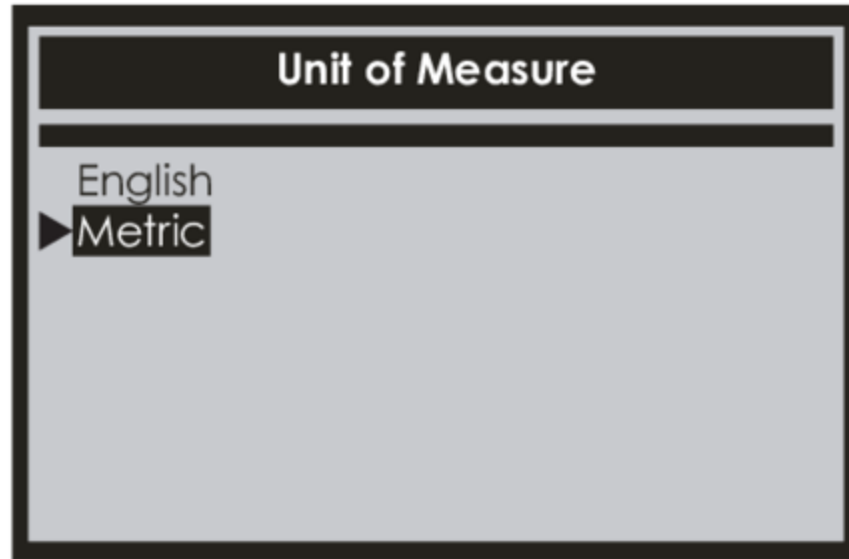

3. Press the ENTER button to save your selection and return to the previous menu.

OBD II Definitions [Mans.io](https://mans.io)

CAUTION: Don't connect or disconnect any test equipment with ignition on or engine running.

1. Turn the ignition off.
2. Locate the vehicle's 16-pin Data Link Connector (DLC).
3. Plug the scan tool cable connector into the vehicle's DLC.
4. Turn the ignition on.

5. Press ENTER to enter Main Menu. Use the UP/DOWN scroll button to select Diagnostics from the menu.



6. Press ENTER to confirm. A sequence of messages displaying the OBD II protocols will be observed on the display until the vehicle protocol is detected

If the scan tool fails to communicate with the vehicle's ECU (Engine Control Unit), a "LINKING ERROR!" message shows up on the display.

- Verify that the ignition is ON;
- Check if the scan tool's OBD II connector is securely connected to the vehicle's DLC;
- Verify that the vehicle is OBD II compliant;
- Turn the ignition 'off' and wait for about 10 seconds. Turn the ignition back to 'on' and repeat the procedure from step 5.

1. Read Codes

- Stored codes are also known as "hard codes" or "permanent codes". These codes cause the control module to illuminate the malfunction indicator lamp (MIL) when an emission-related fault occurs.

- Pending Codes are also referred to as "maturing codes" or "continuous monitor codes". They indicate problems that the control module has detected during the current or last driving cycle, but are not considered serious, yet. Pending Codes will not turn on the malfunction indicator serious, yet. Pending Codes will not turn on the malfunction indicator up cycles, the code clears from memory.

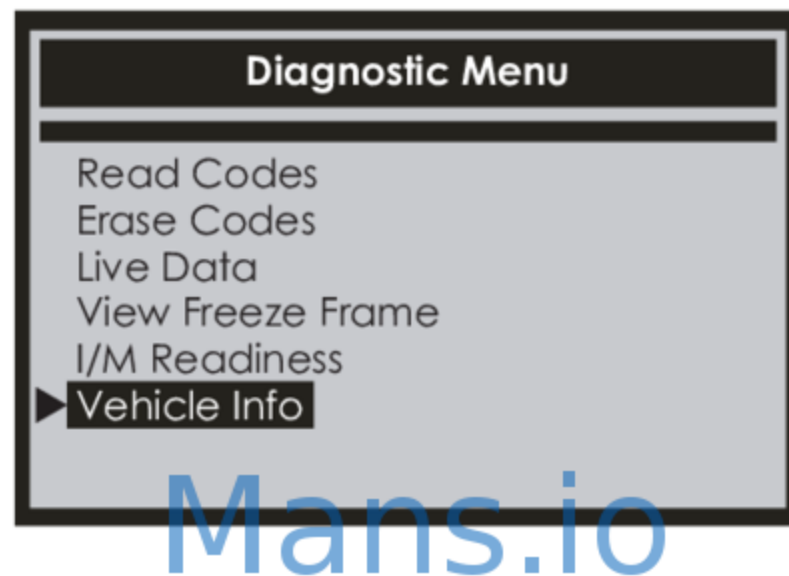

2. Erase Codes

Notes:

- This function is performed with key on engine off . Do not start the engine.
- Before performing this function, make sure to retrieve and record the trouble codes.

- After clearing, you should retrieve trouble codes once more or turn ignition on and retrieve codes again. If there is still some trouble codes for hard troubles, please find the reason caused the trouble code firstly, and then solve the problem. Now, the trouble codes can be erased.

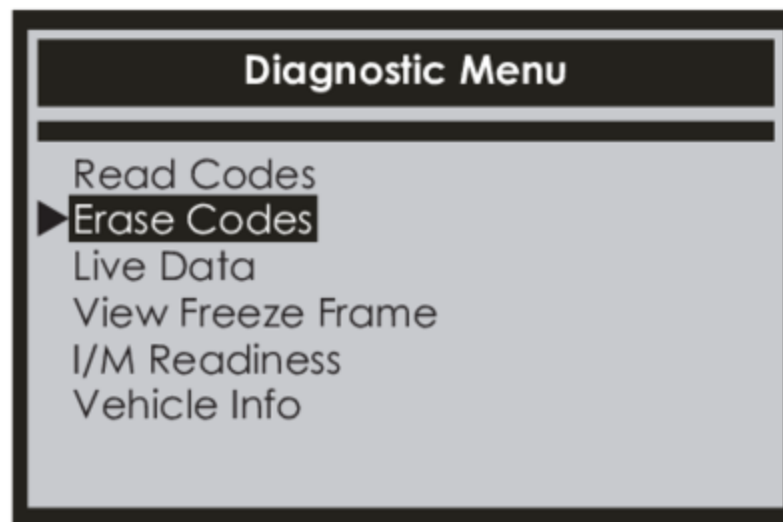

3. Live Data



The OBD II Scan Tool is a special diagnostic tool that communicates with the vehicle's computer. The Scan Tool lets you view "real-time" Live Data. This information includes values (volts, rpm, temperature, speed etc.) and system status information (open loop, closed loop, fuel system status, etc.) generated by the various vehicle sensors, switches and actuators. Press ENTER

Mans.io

4. View Freeze Frame

When an emission-related fault occurs, certain vehicle conditions are recorded by the on-board computer. This information is referred to as freeze frame data. View Freeze Data is a snapshot of the operating conditions at the time of an emission-related fault.

- **If DTCs were erased, View Freeze Data may not be stored in vehicle memory depending on vehicle.**

Use the UP/DOWN scroll button for more PIDs if an  or  arrow appears on the screen. Press EXIT to return to Diagnostic Menu.



5. I/M Readiness

I/M refers to Inspection and Maintenance, that is legislated by the Government to meet federal clean-air standards. I/M Readiness indicates whether or not the various emissions-related systems on the vehicle are operating properly and are ready for Inspection and Maintenance testing. The I/M Readiness Monitor Status function also can be used (after repair of a fault has been performed) to confirm that the repair has been performed correctly, and/or to check for Monitor Run Status.

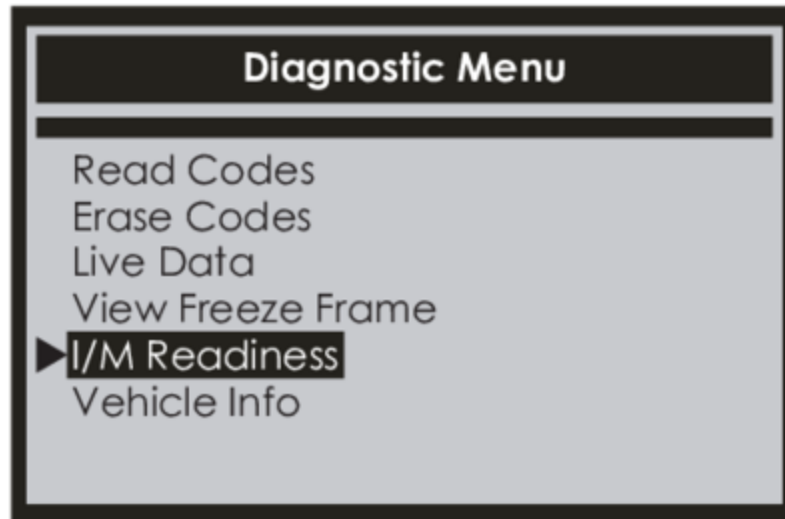

6. Vehicle Info.

Select [Vehicle Info.] and press [ENTER], the screen will display the formation such as VIN (Vehicle identification Number), CID (Calibration ID) and CVN (Calibration verify number).

Mans.io

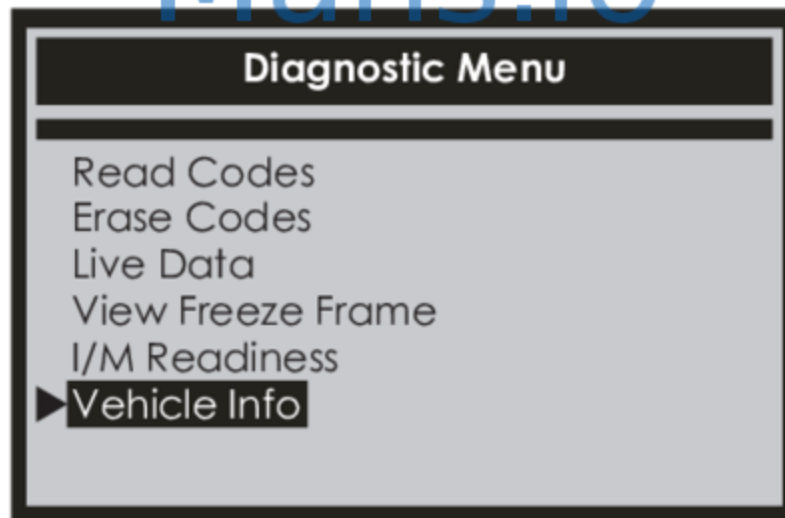

FAQ

1. Support what kind of car?

It support for the 12v voltage,16pin interface,after1996 OBD2 compliant US, European and Asian vehicles.

2. Why the product is connected to vehicle,but still can not read the data?

After plug product into vehicle OBDII interface,put key to the On location or start engine to test again.(if you do not do like that,even if the screen bright, it can not read the data)

3. Why we erased the fault codes,the trouble light still bright?

Fault code is divided into temporary fault codes and permanent fault codes. if it is temporary failure,using our product it is sure to remove.But if it is a permanent fault,even we erased fault code,the trouble light will be bright. It means vehicle issue has not been fundamentally solve.You have to go to 4s shop or repair shop to find a professional maintenance repair.

4. Where is settings of language?

Our product is multilingual configuration,the default language is English, if you want to change the language,you can be in "Setting-language menu click on the "confirm" to choose the required language switching language types.

5. There is no words display just blue screen after product electrify.What should we do?

Please test several times,if it is still blue screen,please contact the nearest suppliers,we will replace a new product for you.

Warranty and Service

1. Limited Two Years Warranty

THIS WARRANTY IS EXPRESSLY LIMITED TO PERSONS WHO PURCHASE JDiag PRODUCTS FOR PURPOSES OF RESALE OR USE IN THE ORDINARY COURSE OF THE BUYER'S BUSINESS.

JDiag electronic product is warranted against defects in materials and workmanship for two years (24 months) from date of delivery to the user.

This warranty does not cover any part that has been abused, altered, used for a purpose other than for which it was intended, or used in a manner inconsistent with instructions regarding use. The exclusive remedy for any automotive meter found to be defective is repair or replacement, and JDiag shall not be liable for any consequential or incidental damages.

Mans.io

Service Procedures

If you have any questions, please send us an email to info@jdiag.com with further details. Let us know in your email, please include your order number to speed up the process.

Model: OM123

Mans.io

JDiag Electronics Technology Co.,Ltd.

Email: info@jdiag.com

Tel: +86-755-21005135

Add: 5th Floor, #1 Building, Bin Xianghua
Industrial area, Huaao Rd, Longhua District,
518000, Shenzhen China.

CE **FC** **RoHS**
Made in China

